

FTP Daemon

COLLABORATORS

	<i>TITLE :</i> FTP Daemon		
<i>ACTION</i>	<i>NAME</i>	<i>DATE</i>	<i>SIGNATURE</i>
WRITTEN BY	Marc Huber	December 3, 2011	

REVISION HISTORY

NUMBER	DATE	DESCRIPTION	NAME

Contents

1	Introduction	1
1.1	Download	1
2	Supported commands	1
3	Operation	2
3.1	Command line syntax	2
3.2	Signals	2
3.3	Event mechanism selection	3
4	Configuration directives	3
4.1	Global Configuration	3
4.1.1	Access Control Lists	4
4.2	ACL-based Configuration	6
4.3	Path-rewriting using PCRE	10
4.4	TLS support	10
4.5	MAVIS Configuration	11
5	Wildcard patterns	11
6	Magic cookie substitution	11
7	Sample configuration	12
8	Railroad Diagrams	13
9	Bugs	18
10	References	18
11	Copyrights and Acknowledgements	19

1 Introduction

This FTP daemon was written from scratch. The list of supported features includes:

- Small memory footprint
- Event-driven, pre-forking
- Not called by inetd
- Supports traffic shaping
- Highly configurable using access control lists for commands and configuration variables
- Utilizes the MAVIS modular authentication system
- A couple of **wu-ftpd**-like features (banners, checksum calculation, ...) are available
- DNS resolving is done if the daemon is compiled with *lwres* support
- Asynchronous RFC1413 ident lookups
- Large File support.
- 64bit clean

1.1 Download

Source and documentation are available from <http://www.pro-bono-publico.de/projects/>.

2 Supported commands

The daemon support several standards and drafts:

- Standard RFC959 FTP commands supported are:

```
ABOR, APPE, CWD, CDUP, DELE, HELP, LIST, NLST, MDTM, MKD, NOOP, PASS,
PASV, PORT, PWD, QUIT, REIN, REST, RETR, RMD, RNFR, RNTO, SITE, SIZE,
STAT, STOR, STOU, SYST, TYPE, USER, XCUP, XCWD, XMKD, XPWD, XRMD
```

- IPv6 support is available. Both the RFC1639 (aka. FOOBAR) extensions (LPRT, LPSV) and the more recent ones defined in RFC2428 (EPRT, EPSV) are supported.
- The feature negotiation commands FEAT and OPTS introduced in RFC2389 are supported.
- The command LANG (RFC2640) allows negotiation of a language for greetings and error messages. Currently supported languages include English and German.
- RFC4217 (Securing FTP with TLS) is supported, If the daemon was compiled with TLS support. AUTH TLS et al. may then be used to switch to a secure channel; certificate authentication is supported. This may or may not be legal in your country
- MDTM and SIZE aren't specified in RFC959, but may become part of a revised FTP specification.
- MLST and MLSL are supported, but the specification is still in draft status.
- The proposed fact modification commands MFMT and MFF are supported.
- Virtual host support is available using the HOST command (requires explicit support via MAVIS backends).
- The experimental commands ESTA and ESTP are available.

- `MODE Z` enables deflate transmission mode. Alternatively, just add `.gz` to a file name for on-the-fly compression.

Various `SITE` commands are available:

- `SITE CHMOD` changes permission modes.
- `SITE GROUP` may be used to switch to another group id.
- `SITE GROUPS` displays the available group ids in **wu-ftpd** style.
- `SITE ID` displays both user id and the available group ids.
- `SITE IDLE` displays or changes the idle timeout.
- `SITE UMASK` displays or changes the current **umask**.
- `SITE CHECKMETHOD` selects a checksum method (either CRC or MD5), as does `OPTS HASH`.
- `SITE CHECKSUM` calculates and displays checksum values, as does `HASH`. The `RANG` command for specifying byte ranges is supported. **wu-ftpd**-like file conversions for `.md5` and `.crc` are implemented.
- `SITE HTPWD` may be useful for maintaining `.htpasswd` compliant password files.
- `SITE HELP` or `SITE HELP COMMAND` display information about available commands and command syntax.

3 Operation

This section gives a brief and basic overview how to run **ftpd**.

In earlier versions, **ftpd** wasn't a standalone program but had to be invoked by **spawnd**. This has changed, as **spawnd** is now part of the **ftpd** binary. However, using a dedicated **spawnd** process is still possible and, more importantly, the **spawnd** configuration options and documentation remain valid.

ftpd may use auxilliary **MAVIS** backend modules for authentication and authorization.

3.1 Command line syntax

The only mandatory argument is the path to the configuration file:

```
ftpd [ -P ] [ -d level ] [ -i child_id ] configuration-file [ id ]
```

If the program was compiled with CURL support, *configuration-file* may be an URL.

Keep the `-P` option in mind - it is imperative that the configuration file supplied is syntactically correct, as the daemon won't start if there are any parsing errors at start-up.

The `-d` switch enables debugging. You most likely don't want to use this. Read the source if you need to.

The `-i` option is only honoured if the build-in **spawnd** functionality is used. In that case, it selects the configuration ID for **ftpd**, while the optional last argument *id* sets the ID of the **spawnd** configuration section.

3.2 Signals

Both the master (that's the process running the **spawnd** code) and the child processes (running the **ftpd** code) intercept the `SIGHUP` signal:

- The master process will restart upon reception of `SIGHUP`, re-reading the configuration file. The child processes will recognize that the master process is no longer available. It will continue to serve the existing connections and terminate when idle.
- If `SIGHUP` is sent to a child process it will stop accepting new connections from its master process. It will continue to serve the existing connections and terminate when idle.

3.3 Event mechanism selection

Several level-triggered event mechanisms are supported. By default, the one best suited for your operating system will be used. However, you may use the environment variable `IO_POLL_MECHANISM` to select a specific one.

The following event mechanisms are supported (in order of preference):

- `port` (Sun Solaris 10 and higher only, `IO_POLL_MECHANISM=32`)
- `kqueue` (*BSD and Darwin only, `IO_POLL_MECHANISM=1`)
- `/dev/poll` (Sun Solaris only, `IO_POLL_MECHANISM=2`)
- `epoll` (Linux only, `IO_POLL_MECHANISM=4`)
- `poll` (`IO_POLL_MECHANISM=8`)
- `select` (`IO_POLL_MECHANISM=16`)

Environment variables can be set in the configuration file at top-level:

```
setenv IO_POLL_MECHANISM = 4
```

4 Configuration directives

Several configuration options are very similar in syntax. For that reason, I'll use a couple of shortcuts below:

- **Boolean:** `yes/permit` or `no/deny`
- **Path:** A valid file path on your system.
- **Number:** A positive integer number.
- **Directory:** A valid directory path on your system.
- **CIDR:** A single IP address or network the latter in Classless Inter-Domain Routing notation (*Address/MaskLength*).

4.1 Global Configuration

The following table summarizes configuration options with plain

Variable = Argument

syntax:

Variable	Description	
mimetypes	This specifies the path to a <code>mime.types</code> file. Mime-types are used for the <i>media-type</i> fact in MLST/MLSD replies.	
	Type of Argument	<i>Path</i>
	Default Value	<i>none</i>
	Example:	
	<code>mimetypes = /etc/mime.types</code>	
buffer size	Permits tuning of buffer allocation size.	
	Type of Argument	<i>Integer</i>
	Default Value	<code>32k</code>

Variable	Description	
buffer mmap-size	Permits tuning of buffer allocation size. Setting <i>mmap-size</i> to 0 will cause whole files to be memory-mapped. However, if you do so on a 32bit system, it may run out of address space.	
	Type of Argument	<i>Integer</i>
	Default Value	256k (on 64bit systems: unlimited)
hide-version	This options controls whether the daemon will omit its version number in the HELP response.	
	Type of Argument	<i>Boolean</i>
	Default Value	no
retire	If set, the daemon will terminate after processing <i>count</i> sessions, what may be useful to remedy the effects of memory leaks.	
	Type of Argument	<i>Integer</i>
	Default Value	<i>unset</i>
log-format command	Sets format for logging to syslog.	
	Type of Argument	<i>String</i>
	Default Value	"CMD %i %r %I %t %u %C %- c"
log-format event	Sets format for logging to syslog.	
	Type of Argument	<i>String</i>
	Default Value	"EVE %i %r %I %u %t %d"
log-format transfer	Sets format for logging to syslog.	
	Type of Argument	<i>String</i>
	Default Value	"XFR %i %r %I %t %u %d %- m %b %s %D %c"
log-format delimiter	All occurrences of the <i>delimiter</i> character will be replaced by the <i>substitute</i> character before logging.	
	Type of Argument	<i>Character</i>
	Default Value	" "
log-format substitute	All occurrences of the <i>delimiter</i> character will be replaced by the <i>substitute</i> character before logging.	
	Type of Argument	<i>Character</i>
	Default Value	" _ "
nlst	This directive may be used to limit output of the NLST command to regular files. It is provided for wu-ftpd compatibility.	
	Argument	files-only
	Default Value	<i>unset</i>
use-mmap	On systems supporting memory-mapped I/O, the daemon may use <i>mmap(2)</i> for read-only file access. Preliminary tests indicated that <i>mmap(2)/write(2)</i> improves binary file transfer performance by about 12% compared to <i>read(2)/write(2)</i> . ASCII transfers and checksum calculations show better performance, too. The daemon will automatically fall back to standard I/O if the <i>mmap(2)</i> syscall fails.	
	Argument	<i>Boolean</i>
	Default Value	yes
use-sendfile	On systems supporting <i>sendfile(2)</i> , the daemon may use that syscall for binary file transfers. Preliminary tests indicated that <i>sendfile(2)</i> improves performance by about 18% compared to <i>read(2)/write(2)</i> , and by about 5% compared to <i>mmap(2)/write(2)</i> . The daemon will automatically fall back to memory mapped or standard I/O if the <i>sendfile(2)</i> syscall fails.	
	Argument	<i>Boolean</i>
	Default Value	yes

4.1.1 Access Control Lists

Various configuration directives may depend on ACLs. ACL syntax is

```
acl ACLName = { ... }
```

To be more precisely, the above doesn't specify a complete ACL, but adds a ACL rule to *ACLName*. As such, an `acl` declaration may be used multiple times, and the ACL rule will just be added to the end of the current rule list. Likewise, ACL rules are evaluated sequentially, in the order of definition.

Inside the curly brackets, recognized matching criteria are:

- `src = [not] CIDR`
(matches source address of client)
- `dst = [not] CIDR`
(matches local destination address)
- `authenticated = [not] (yes | no | real | anon)`
(matches if the user has authenticated as a `real` or anonymous user; `yes` matches both)
- `protected = Boolean`
(matches according to the TLS protection status)

- `time = [not] TimeSpecName`
Matches depending on current time.

`timespec` objects may be used for time based profile assignments. Both `cron` and `Taylor-UUCP` syntax are supported, see you local `crontab(5)` and/or `UUCP` man pages for details. Syntax:

```
timespec = timespec_name { "entry" [ ... ] }
```

Example:

```
# Working hours are from Mo-Fr from 9 to 16:59, and
# on Saturdays from 9 to 12:59:
timespec = workinghours {
    "* 9-16 * * 1-5" # or: "* 9-16 * * Mon-Fri"
    "* 9-12 * * 6" # or: "* 9-12 * * Sat"
}

timespec = sunday { "* * * * 0" }

timespec = example {
    Wk2305-0855, Sa, Su2305-1655
    Wk0905-2255, Su1705-2255
    Any
}
```

- `user = [not] [regex] [caseless] User`
(matches current user name verbatim or as POSIX regular expression)
- `arg = [not] [regex] [caseless] Arg`
(matches command argument verbatim or as POSIX regular expression)
- `path = [not] [regex] [caseless] Path`
(matches path verbatim or as POSIX regular expression)
- `host = [not] [regex] [caseless] Host`
(matches virtual host name verbatim or as POSIX regular expression)

For `src` and `dst` multiple definitions may be given within the same rule.

Example:

```

acl rfc1918 = {
    src = 127.0.0.1
    src = 10.0.0.0/8
    src = 172.16.0.0/12
    src = 192.168.0.0/16
}

acl ipv6_any = {
    src = ::0
}

acl notsunday = {
    time = workinghours
}

acl test001 = {
    arg regex = ^.cshrc$
    authenticated = real
}

acl test002 = {
    user = root
    authenticated = real
}

```

These are predefined:

```

acl = secure { protected = yes }
acl = any { }
acl = connect { }
acl = real { authenticated = real }
acl = anon { authenticated = anon }
acl = login { authenticated = yes }

```

4.2 ACL-based Configuration

The following table summarizes configuration options with

Variable [acl [not] AclName] = Argument

syntax. Example:

```

access acl not someacl = permit
access acl otheracl = permit
access = deny

```

Variable	Description	
access	Grants initial connection setup based on ACLs.	
	Type of Argument	<i>Boolean</i>
	Default Value	permit
address-mismatch	Permit or deny address mismatches between data and control channel, only necessary for server-to-server transfers.	
	Type of Argument	<i>Boolean</i>
	Default Value	deny
ascii-size-limit	Sets an upper file size limit for size calculations in ASCII transfer mode.	
	Type of Argument	<i>Number</i>
	Default Value	<i>unset</i>
authentication-failures max	Sets an upper limit for authentication failures. Stop verifying authentication after limit is exceeded, just reject.	

Variable	Description	
	Type of Argument	<i>Number</i>
	Default Value	5
authentication-failures bye	Terminate connection after the specified number of authentication failures.	
	Type of Argument	<i>Number</i>
	Default Value	10
	Example:	
	authentication-failures bye = 5	
auto-conversion checksum	Allow or deny on-the-fly calculation of checksum (*.md5, *.crc) files.	
	Type of Argument	<i>Boolean</i>
	Default Value	deny
auto-conversion (gzip deflate)	Allow or deny on-the-fly compression to gzip (deflate) format by appending .gz to the filename.	
	Type of Argument	<i>Boolean</i>
	Default Value	deny
	Example:	
	acl may-compress = { path = regex "\.(txt doc)\$" } auto-conversion gzip acl may-compress = permit	
banner	Specifies a file to be displayed before the initial greeting message. Magic cookie substitution applies.	
	Type of Argument	<i>Path</i>
	Default Value	<i>unset</i>
banner-action	Terminates the session after displaying a banner.	
	Argument	logout
	Default Value	<i>unset</i>
binary-only	Rejects non-binary file transfers. Will also be evaluated for SIZE calculations in ASCII mode.	
	Type of Argument	<i>Boolean</i>
	Default Value	deny
	Example:	
	acl binary = { path = regex "\.(gif jpg mp3)\$" } binary-only acl binary = permit	
check-uid	If enabled, only files belonging to the actual user are accessible.	
	Type of Argument	<i>Boolean</i>
	Default Value	no
check-gid	If enabled, only files belonging to the actual user's group are accessible.	
	Type of Argument	<i>Boolean</i>
	Default Value	no
check-perm	If enabled, only publicly accessible files are permitted.	
	Type of Argument	<i>Boolean</i>
	Default Value	no
chmod-mask (file directory)	Bits set in <i>mask</i> can not be removed using the SITE UMASK or SITE CHMOD commands.	
	Type of Argument	<i>Octal</i>
	Default Value	<i>unset</i>
	Example:	

Variable	Description	
	<pre>chmod-mask file = 0600</pre>	
deflate-level (min max default)	These parameters set and/or limit the deflate compression level for both transmission-mode = z and auto-conversion gzip. Valid levels are from 0 to 9.	
	Type of Argument	<i>Number</i>
	Default Value	<i>unset</i>
	Example:	<pre>deflate-level default = 7</pre>
dotfiles	Permit or deny access to files starting with a dot.	
	Type of Argument	<i>Boolean</i>
	Default Value	<i>deny</i>
fake-group	Sets the group name to display in directory listings if resolving the GID is not possible or deactivated with the <i>resolve-ids</i> clause.	
	Type of Argument	<i>String</i>
	Default Value	<i>ftp</i>
fake-owner	Sets the user name to display in directory listings if resolving the UID is not possible or deactivated with the <i>resolve-ids</i> clause.	
	Type of Argument	<i>String</i>
	Default Value	<i>ftp</i>
goodbye	Specifies the absolute path to some file to be displayed at logout time. Magic cookie substitution applies.	
	Type of Argument	<i>Path</i>
	Default Value	<i>unset</i>
greeting	Specifies the initial greeting message in 220 response. Magic cookie substitution applies.	
	Type of Argument	<i>String</i>
	Default Value	<i>"Welcome, pilgrim."</i>
	Example:	<pre>greeting = "%L FTP server (Version %V) "</pre>
hostname	Sets the the virtual hostname for the current session.	
	Type of Argument	<i>String</i>
	Default Value	<i>"misconfigured.host"</i>
ident	If enabled, ftpd will attempt to query the remote RFC1413 daemon (if any) for the remote user name, which is informal only and may be used in banners using the %u modifier. The ident query is performed asynchronously and doesn't defer the login process.	
	Type of Argument	<i>Boolean</i>
	Default Value	<i>no</i>
maintainer	Sets the site maintainers email address.	
	Type of Argument	<i>String</i>
	Default Value	<i>unset</i>
log	Enables logging for the specified <i>LogTypes</i> (command, transfer, event, ident)	
	Type of Argument	<i>LogType</i>
	Default Value	<i>unset</i>
	Example:	

Variable	Description				
	<code>log acl someacl = ident command transfer</code>				
passive address	Specify the IP address used in PASV replies. Might be useful for NAT.				
	<table border="1"> <tr> <td>Type of Argument</td> <td><i>IPAddress</i></td> </tr> <tr> <td>Default Value</td> <td><i>unset</i></td> </tr> </table>	Type of Argument	<i>IPAddress</i>	Default Value	<i>unset</i>
Type of Argument	<i>IPAddress</i>				
Default Value	<i>unset</i>				
passive port (min max)	Specify the port range for PASV replies.				
	<table border="1"> <tr> <td>Type of Argument</td> <td><i>Number</i></td> </tr> <tr> <td>Default Value</td> <td><i>unset</i></td> </tr> </table>	Type of Argument	<i>Number</i>	Default Value	<i>unset</i>
Type of Argument	<i>Number</i>				
Default Value	<i>unset</i>				
readme	Specifies the file to be displayed upon entering a directory. That file needs to be world-readable, or it may or may not be displayed. If <i>File</i> contains '%s', the daemon will substitute that character sequence with and '-' plus the current language abbreviation, e.g. '-en' or '-de'. If that fails, '%s' will be substituted with an empty string. More than one occurrence of '%s' in <i>file</i> will most likely result in a segmentation fault. Magic cookie substitution applies.				
	<table border="1"> <tr> <td>Type of Argument</td> <td><i>File</i></td> </tr> <tr> <td>Default Value</td> <td><i>unset</i></td> </tr> </table>	Type of Argument	<i>File</i>	Default Value	<i>unset</i>
	Type of Argument	<i>File</i>			
Default Value	<i>unset</i>				
Display the <code>readme</code> file only once.					
readme-once	<table border="1"> <tr> <td>Type of Argument</td> <td><i>Boolean</i></td> </tr> <tr> <td>Default Value</td> <td><i>unset</i></td> </tr> </table>	Type of Argument	<i>Boolean</i>	Default Value	<i>unset</i>
	Type of Argument	<i>Boolean</i>			
Default Value	<i>unset</i>				
readme-notify	Notify that the <code>readme</code> file exists, but don't display it.				
	<table border="1"> <tr> <td>Type of Argument</td> <td><i>Boolean</i></td> </tr> <tr> <td>Default Value</td> <td><i>unset</i></td> </tr> </table>	Type of Argument	<i>Boolean</i>	Default Value	<i>unset</i>
Type of Argument	<i>Boolean</i>				
Default Value	<i>unset</i>				
resolve-ids	If set to <code>deny</code> hides real file ownerships.				
	<table border="1"> <tr> <td>Type of Argument</td> <td><i>Boolean</i></td> </tr> <tr> <td>Default Value</td> <td><i>deny</i></td> </tr> </table>	Type of Argument	<i>Boolean</i>	Default Value	<i>deny</i>
Type of Argument	<i>Boolean</i>				
Default Value	<i>deny</i>				
shape-bandwidth	Establish a session-based upper limit for outgoing bandwidth. The argument is the absolute bandwidth available for the session.				
	<table border="1"> <tr> <td>Type of Argument</td> <td><i>Number</i></td> </tr> <tr> <td>Default Value</td> <td><i>unset</i></td> </tr> </table>	Type of Argument	<i>Number</i>	Default Value	<i>unset</i>
	Type of Argument	<i>Number</i>			
Default Value	<i>unset</i>				
symlinks	Specify which symbolic links to trust. This option is quite critical for system security and defaults to <code>none</code> . Recognized keywords:				
	<ul style="list-style-type: none"> • <code>all</code> - accept all symbolic links • <code>none</code> - ignore all symbolic links • <code>root</code> - accept symbolic links owned by root • <code>same</code> - accept symbolic links owned by owner of target • <code>real</code> - accept symbolic links for non-anonymous users 				
	<table border="1"> <tr> <td>Type of Argument</td> <td><i>SymlinkType</i></td> </tr> <tr> <td>Default Value</td> <td><i>unset</i></td> </tr> </table>	Type of Argument	<i>SymlinkType</i>	Default Value	<i>unset</i>
	Type of Argument	<i>SymlinkType</i>			
	Default Value	<i>unset</i>			
Example:					
<code>symlinks = root same real</code>					
accept timeout	Sets the timeout for establishing incoming data connections.				
	<table border="1"> <tr> <td>Type of Argument</td> <td><i>Seconds</i></td> </tr> <tr> <td>Default Value</td> <td>30</td> </tr> </table>	Type of Argument	<i>Seconds</i>	Default Value	30
	Type of Argument	<i>Seconds</i>			
Default Value	30				
connect timeout	Sets the timeout for establishing outgoing data connections.				
	<table border="1"> <tr> <td>Type of Argument</td> <td><i>Seconds</i></td> </tr> <tr> <td>Default Value</td> <td>30</td> </tr> </table>	Type of Argument	<i>Seconds</i>	Default Value	30
	Type of Argument	<i>Seconds</i>			
Default Value	30				

Variable	Description	
idle timeout (default min max)	This option sets the default, minimum and maximum session timeouts, the latter two for <code>SITE IDLE</code> .	
	Type of Argument	Seconds
	Default Value	600
transmission-mode z	Enables/disables the Z transmission mode. When enabled, <i>deflate</i> data transfer compression may be used. This option is only available if the software was compiled with zlib support.	
	Type of Argument	Boolean
	Default Value	deny
umask	Specifies the default umask. Both MAVIS derived umasks and umasks set with the <code>SITE UMASK</code> command have higher priority. Defaults to 022	
	Type of Argument	Octal
	Default Value	022
welcome	Specifies a file to be displayed just after login. Magic cookie substitution applies.	
	Type of Argument	Path
	Default Value	unset
welcome-action	Terminates the session after displaying the welcome message.	
	Argument	logout
	Default Value	unset

FTP commands may depend on ACLs, too. Syntax for that is:

```
command = [ site ] Command { ( acl [ not ] ACLName = [ log ] ( permit | deny ) ) * }
```

Example:

```
command = site chmod { acl connect = log permit }
command = pass { acl not real = log permit }
```

4.3 Path-rewriting using PCRE

If compiled with PCRE (Perl Compatible Regular Expressions) support,

```
rewrite perl-regex replacement [ flags ]
```

may be used to implement Perl-like file path rewriting rules. Valid flags are L (last), N (next) and R (reject). $\$n$ (or $\$\{n\}$ for $n > 9$) in *replacement* will be substituted by the corresponding match in *perl-regex*. This option is available only if PCRE support is compiled in. Example:

```
rewrite ^/ftp/mirror-(.*)$ /ftp/mirror/$1
rewrite ^/tmp/test/(..)$ /tmp/test
rewrite ^/tmp/test/..*$ $0 L
rewrite ^/tmp/test/(..)(.*) /tmp/gaga/${1}/${1}$2 L
rewrite ^/tmp/test123 $0 R
```

4.4 TLS support

If compiled with TLS support, various TLS related parameters may be specified. Most of the options should be obvious enough:

- `tls certfile = CertFile`
- `tls keyfile = KeyFile`
- `tls passphrase = PassPhrase`
- `tls auth = Boolean`

- `tls required` = *Boolean*
- `tls cafile` = *CAFile*
- `tls capath` = *CAPath*
- `tls depth` = *Depth*
- `tls ciphers` = *Ciphers*
- `tls old-draft` = *Boolean*

The `auth` keyword enables client certificate based authentication. This requires some further configuration within the `auth` MAVIS module. Certificate based authentication will require at least OpenSSL version 0.9.7.

If `old-draft` is specified, the daemon responds with a 234 instead of a 334 message after successfully negotiating TLS. This enables use of clients conforming to older versions of `draft-murray-auth-ftp-ssl`. It is recommended not to use that option, but to fix the client.

`keyfile` may be omitted, it defaults to *CertFile*.

All this is unset by default.

4.5 MAVIS Configuration

Directives to configure the MAVIS backends are:

- `mavis module` = *module* { ... }
Load MAVIS module *module*. See the MAVIS documentation for configuration guidance.
- `mavis path` = *path*
Add *path* to the search-path for MAVIS modules.

5 Wildcard patterns

Limited file name globbing for the `LIST` and `NLIST` commands is implemented for files in the current working directory.

Recognized glob patterns are:

- `*` matches any string, including the empty string
- `?` matches any single character
- `[...]` matches exactly one single character between the brackets. If the first character inside the brackets is a `!`, the expression matches the complement. If it is a `]` it matches the literal `]`. Two characters separated by `-` denote a range.

For the `CWD` command only, a tilde (`~`) character at the beginning of the argument expands to the users home directory.

6 Magic cookie substitution

The magic cookies used are partially compatible to those utilized by **wu-ftpd**. Text and files specified using the configuration directives **banner**, **goodbye**, **greeting**, **readme** and **welcome** are subject to cookie substitution.

Available conversions are:

- `%A` - number of transfers

- %B - build time
- %C - current working directory as displayed to user
- %D - time for last transfer
- %E - maintainer
- %F - number of files transferred
- %H - virtual host if set, local hostname else
- %I - identity - user name for real users, email or empty else
- %L - local hostname
- %P - email for anonymous users, empty string else
- %R - remote host name, [%r] if unavailable
- %T - local time
- %U - user name
- %V - version number
- %a - total number of bytes transferred
- %b - bytes transferred during last transfer
- %c - command or file name
- %d - direction of transfer (**In**, **Out**, **in failed**, **out failed**, **X**: aborted)
- %e - event (login, logout or reject)
- %f - number of bytes for file transfers
- %i - unique session id
- %l - local ip address
- %m - transfer mode (**ascii** or **binary**)
- %r - remote ip address
- %s - file size of last transferred file
- %t - type of user (**real**, **anonymous** or **unknown**)
- %u - user name from RFC1413 lookup
- %% - literal percent sign

7 Sample configuration

This is from the `ftpd/sample` directory:

```

#!../obj.darwin-9.6.0-i386/ftpd
id = spawn {
  listen = { port = 2121 }
  spawn = {
    instances min = 1
  }
  background = no
}

id = ftpd {
  debug = NET CMD
  mavis path = ../../mavis/obj.darwin-9.6.0-i386

  mavis module = anonftp {
    userid = 100
    groupid = mail
    home = /
    root = /tmp/
    upload = /tmp/incoming/
  }
  symlinks = all
  check-uid = no
  check-gid = no
  check-perm = no
}

```

8 Railroad Diagrams



Railroad diagram: `AcceptExpr`

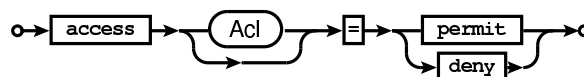

Railroad diagram: `AccessExpr`

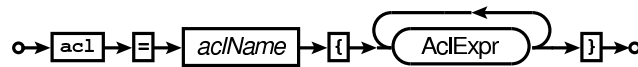

Railroad diagram: `AcIDecl`

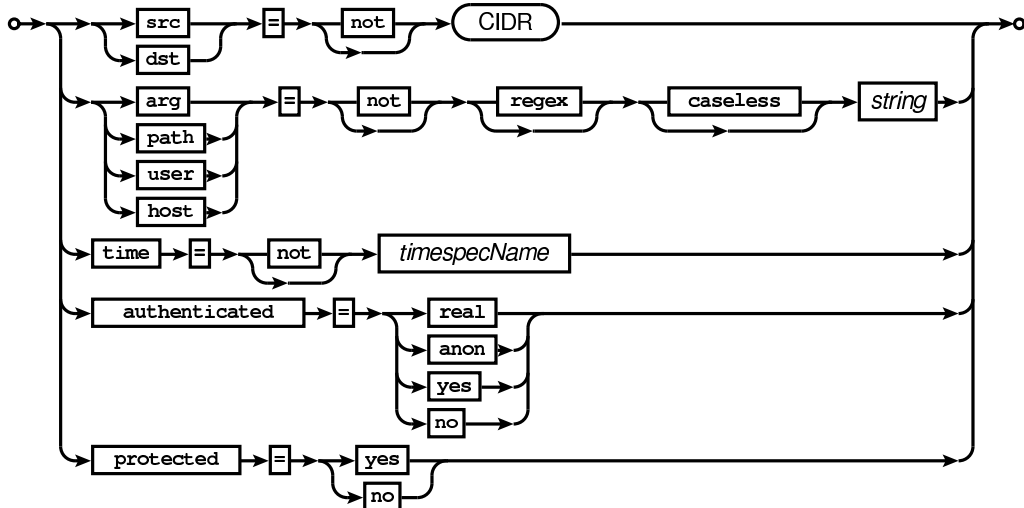

Railroad diagram: AclExpr

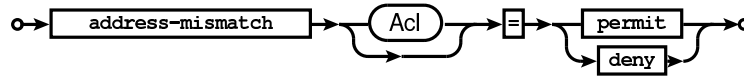

Railroad diagram: AddressMismatchExpr



Railroad diagram: AllowDotfilesExpr

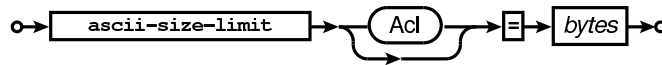

Railroad diagram: AsciiSizeExpr

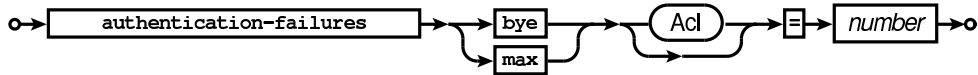

Railroad diagram: AuthFailExpr

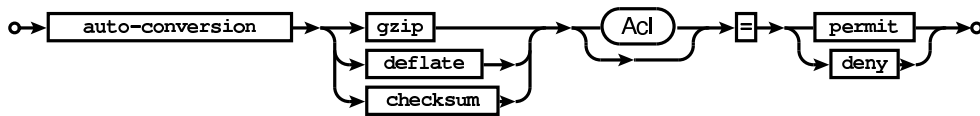

Railroad diagram: AutoConvExpr



Railroad diagram: BannerActionExpr

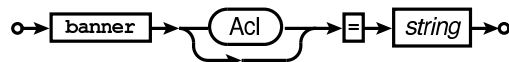

Railroad diagram: BannerExpr

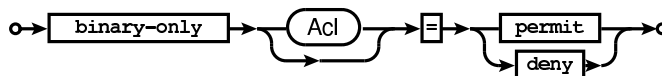

Railroad diagram: BinaryOnlyExpr

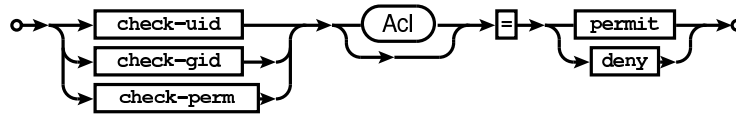

Railroad diagram: *CheckExpr*

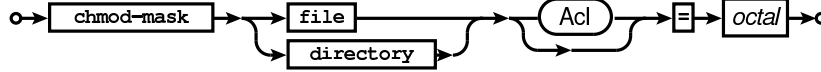

Railroad diagram: *ChmodMaskExpr*

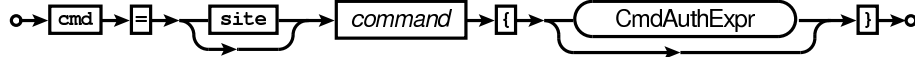

Railroad diagram: *CmdAuth*

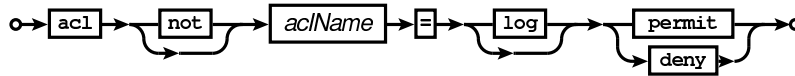

Railroad diagram: *CmdAuthExpr*

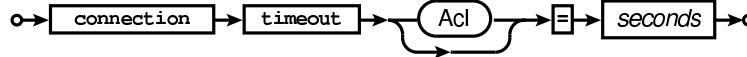

Railroad diagram: *ConnectExpr*

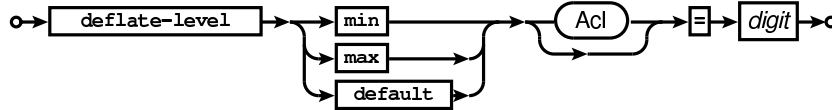

Railroad diagram: *DeflateLevelExpr*

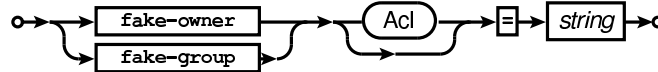

Railroad diagram: *FakeIdExpr*

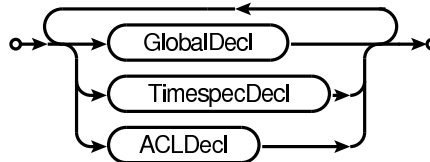

Railroad diagram: *FtpdConfig*

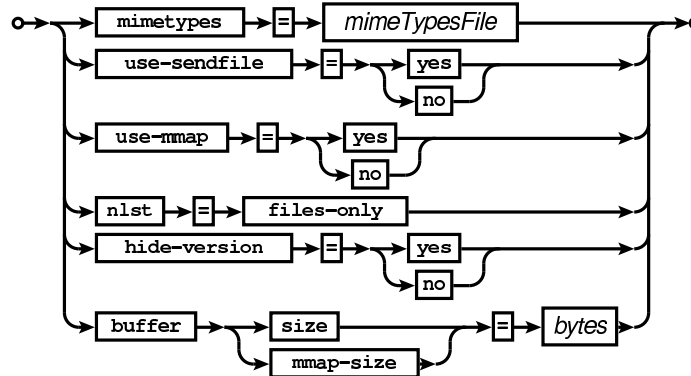

Railroad diagram: *GlobalDecl*



Railroad diagram: GoodbyeExpr

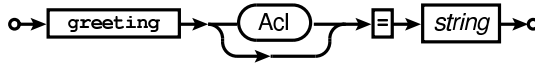

Railroad diagram: GreetingExpr

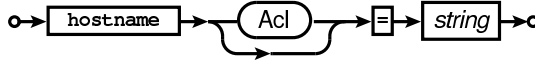

Railroad diagram: HostnameExpr

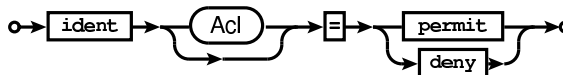

Railroad diagram: IdentExpr

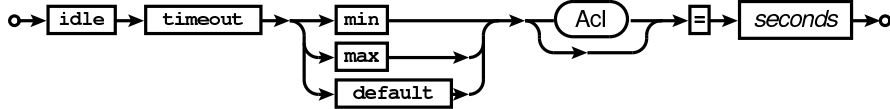

Railroad diagram: IdleExpr

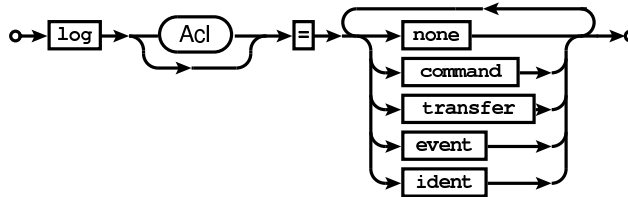

Railroad diagram: LogExpr

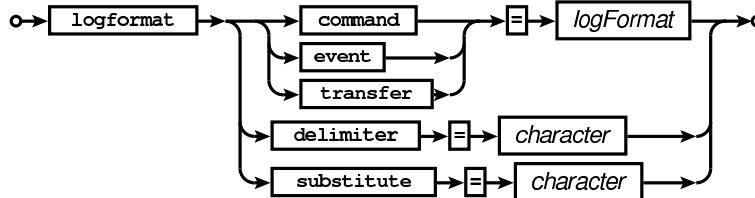

Railroad diagram: LogFormatExpr



Railroad diagram: MaintainerExpr

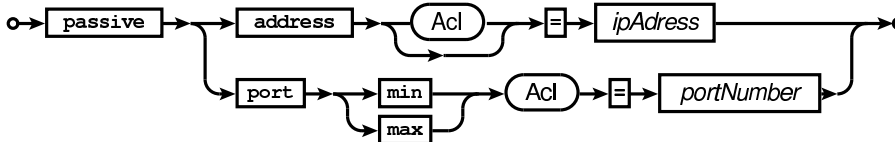

Railroad diagram: PassiveExpr

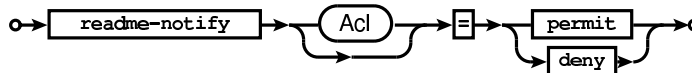

Railroad diagram: ReadmeNotifyExpr

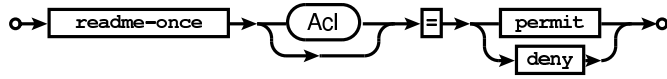

Railroad diagram: ReadmeOnceExpr

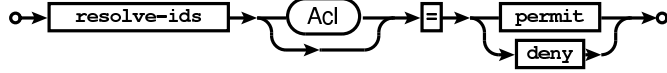

Railroad diagram: ResolveIDsExpr

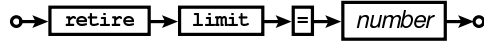

Railroad diagram: RetireExpr



Railroad diagram: RewriteExpr



Railroad diagram: ShapeBwExpr

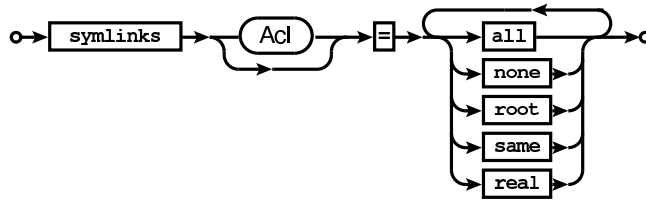

Railroad diagram: SymlinksExpr

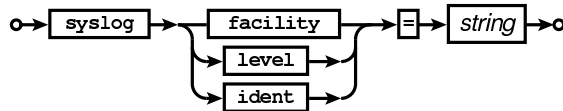

Railroad diagram: SyslogExpr

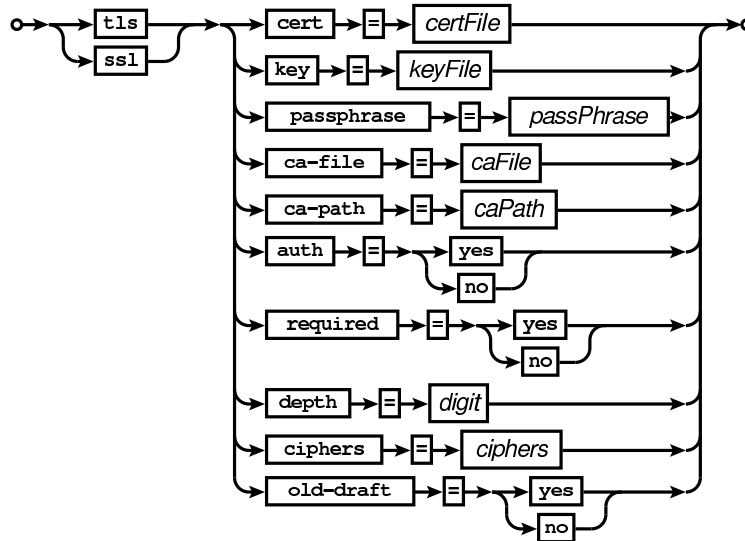

Railroad diagram: TLSExpr

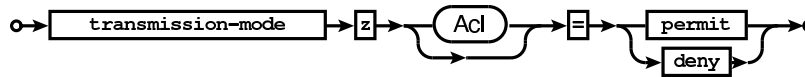

Railroad diagram: *TransModeExpr*

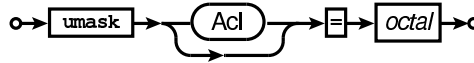

Railroad diagram: *UmaskExpr*



Railroad diagram: *WelcomeActionExpr*

9 Bugs

- The server doesn't perform a `chroot(2)`.
- `Ftpd` has to be started by the super-user unless a non-privileged (and such non-standard) port is used.
- The `LIST` algorithm doesn't permit recursive directory listings, and output differs from POSIX (no `total` line at start of directory listing). However, I don't consider this a serious deficiency, as `LIST` output isn't standardized anyway.
- TLS re-negotiation is currently untested and may or may not work.
- UTF-8 support is likely to be incomplete or plain broken.
- There may still be some nasty bugs lurking in the code. Please contact the author via the "Event-Driven Servers" Google Group at event-driven-servers@googlegroups.com or <http://groups.google.com/group/event-driven-servers> if you think you've found one.

10 References

The FTP Daemon hopefully conforms to the following standards and drafts:

- RFC959 - File Transfer Protocol
- RFC1123 - Requirements for Internet hosts - application and support
- RFC1321 - The MD5 Message-Digest Algorithm
- RFC1413 - Identification Protocol
- RFC1639 - FTP Operation Over Big Address Records (FOOBAR)
- RFC2044 - UTF-8, a transformation format of Unicode and ISO 10646
- RFC2228 - FTP Security Extensions
- RFC2389 - Feature negotiation mechanism for the File Transfer Protocol
- RFC2428 - FTP Extensions for IPv6 and NATs
- RFC2577 - FTP Security Considerations
- RFC2640 - Internationalization of the File Transfer Protocol
- RFC4217 - Securing FTP with TLS
- draft-ietf-ftpext-mlst-15.txt - Extensions to FTP

- draft-ftptext-data-connection-assurance-00.txt - FTP Data Connection Assurance
- draft-somers-ftp-mfxx-03.txt - The "MFMT", "MFCT", and "MFF" Command Extensions for FTP
- draft-preston-ftptext-deflate-03.txt - Deflate transmission mode for FTP
- draft-hethmon-mcmurray-ftp-hosts-02.txt - File Transfer Protocol HOST Command
- draft-ietf-ftptext2-hash-01 - File Transfer Protocol HASH Command for Cryptographic Hashes
- draft-bryan-ftp-range-01 - File Transfer Protocol RANG Command for Byte Ranges

11 Copyrights and Acknowledgements

Please see the source for copyright and licensing information of individual files.

- **The following applies if the software was compiled with TLS support:**

This product includes software developed by the OpenSSL Project for use in the OpenSSL Toolkit (<http://www.openssl.org/>).

This product includes cryptographic software written by Eric Young (eay@cryptsoft.com).

- **If the software was compiled with PCRE (Perl Compatible Regular Expressions) support, the following applies:**

Regular expression support is provided by the PCRE library package, which is open source software, written by Philip Hazel, and copyright by the University of Cambridge, England.

(<ftp://ftp.csx.cam.ac.uk/pub/software/programming/pcre>).

- **MD5 algorithm:**

The software uses the RSA Data Security, Inc. MD5 Message-Digest Algorithm.

- **Deflate (gzip) compression support** is implemented using the `zlib` library written by Jean-loup Gailly (jloup@gzip.org) and Mark Adler (madler@alumni.caltech.edu).

- **The original `tac_plus` code (which this software and considerable parts of the documentation are based on) is distributed under the following license:**

Copyright (c) 1995-1998 by Cisco systems, Inc.

Permission to use, copy, modify, and distribute this software for any purpose and without fee is hereby granted, provided that this copyright and permission notice appear on all copies of the software and supporting documentation, the name of Cisco Systems, Inc. not be used in advertising or publicity pertaining to distribution of the program without specific prior permission, and notice be given in supporting documentation that modification, copying and distribution is by permission of Cisco Systems, Inc.

Cisco Systems, Inc. makes no representations about the suitability of this software for any purpose. THIS SOFTWARE IS PROVIDED ``AS IS'' AND WITHOUT ANY EXPRESS OR IMPLIED WARRANTIES, INCLUDING, WITHOUT LIMITATION, THE IMPLIED WARRANTIES OF MERCHANTABILITY AND FITNESS FOR A PARTICULAR PURPOSE.

- **The code written by Marc Huber is distributed under the following license:**

Copyright (C) 1999-2011 Marc Huber (Marc.Huber@web.de). All rights reserved.

Redistribution and use in source and binary forms, with or without modification, are permitted provided that the following conditions are met:

1. Redistributions of source code must retain the above copyright notice, this list of conditions and the following disclaimer.
2. Redistributions in binary form must reproduce the above copyright notice, this list of conditions and the following disclaimer in the documentation and/or other materials provided with the distribution.
3. The end-user documentation included with the redistribution, if any, must include the following acknowledgment:

This product includes software developed by Marc Huber (Marc.Huber@web.de).

Alternately, this acknowledgment may appear in the software itself, if and wherever such third-party acknowledgments normally appear.

THIS SOFTWARE IS PROVIDED ``AS IS'' AND ANY EXPRESSED OR IMPLIED WARRANTIES, INCLUDING, BUT NOT LIMITED TO, THE IMPLIED WARRANTIES OF MERCHANTABILITY AND FITNESS FOR A PARTICULAR PURPOSE ARE DISCLAIMED. IN NO EVENT SHALL ITS AUTHOR BE LIABLE FOR ANY DIRECT, INDIRECT, INCIDENTAL, SPECIAL, EXEMPLARY, OR CONSEQUENTIAL DAMAGES (INCLUDING, BUT NOT LIMITED TO, PROCUREMENT OF SUBSTITUTE GOODS OR SERVICES; LOSS OF USE, DATA, OR PROFITS; OR BUSINESS INTERRUPTION) HOWEVER CAUSED AND ON ANY THEORY OF LIABILITY, WHETHER IN CONTRACT, STRICT LIABILITY, OR TORT (INCLUDING NEGLIGENCE OR OTHERWISE) ARISING IN ANY WAY OUT OF THE USE OF THIS SOFTWARE, EVEN IF ADVISED OF THE POSSIBILITY OF SUCH DAMAGE.
